

***Star* RFK101**

PIN & Proximity Card Reader



Table of Contents

1. Important Safety Instructions	3
2. General	3
3. Features	4
4. Identifying Supplied Parts	4
5. Specification	5
6. Installation.....	6
7. Wire Color Table of the Reader	7
8. Wire Connection to Access Controller	7
9. Operation.....	8
10. Output Format.....	10
11. FCC Registration Information.....	13
12. Warranty Policy and Limitation of Liability	13
13. Template	15

1. Important Safety Instructions

When using your **PIN & Proximity Card Reader**, basic safety precautions should always be followed to reduce the risk of fire, electrical shock, and injury to persons.

In addition, the following should also be followed:

1. Read and understand all instructions.
2. Follow all warnings and instructions marked on the product.
3. **Do not** use liquid cleaners or aerosol cleaners. Use a damp cloth for cleaning. If necessary, use mild soap.
4. **Do not** use this product near water, such as bath-tub, wash bowl, kitchen sink, laundry tub, in a wet basement, or swimming pool.
5. This product should be operated only from the type of power source indicated on the marking label. If you are not sure of the type of power supplied to your installation site, consult your dealer or local power company.
6. **Never** push objects of any kind into this product or through the cabinet slots as they may touch voltage points or short out parts that could result in fire or electric shock. Never spill liquid of any kind on the product.
7. To reduce the risk of electric shock, do not disassemble this product by yourself, but take it to qualified service whenever service or repair is required. Opening or removing the covers may expose you to dangerous voltages or other risks. Also, incorrect reassembly can cause electric shock when the unit is subsequently used.
8. **Unplug** this product from the Direct Current (DC) power source and refer to qualified service personnel under these conditions:
 - a. When the power supply cord or plug is damaged or frayed.
 - b. If liquid has been spilled on the product.
 - c. If the product does not operate normally after following the operating instructions in this manual. Adjust only those controls that are covered by the operating instructions in this manual. Improper adjustment of other controls that are not covered by this manual may damage the unit and will often require extensive work by a qualified technician to restore normal operation.
 - d. If the product exhibits a distinct change in performance.

2. General

The **Star RFK101** is an elegant and attractive looking 10cm (4") read range proximity reader with a Keypad. The **Star RFK101** has backlighting on the Keypad that ensures you successful operation even at night. The **Star RFK101** allows you to access the door with proximity card and PIN numbers. Three LEDs of green, yellow and red colors and the built-in Piezo buzzer sound will guarantee you accurate and reliable system operations.

3. Features

- 125KHz Proximity & PIN Reader
- PSK Modulation (IDTECK Format)
- Read Range: Up to 4inch (10cm)
- User format available
- Output Format:
 - » Card: 26bit Wiegand (default) / RS232 and ABA Track II (optional)
 - » Keypad: 26bit Wiegand, 4 / 8bit Burst for PIN Output Format Selectable
- 12-Key Numeric Keypad with Back Lighting
- External LED Control / External Buzzer Control
- Tamper Switch
- Wall Mount (US, EU, Asian Gang Box Size)
- Reverse Polarity Protection
- Options:
 - 3 Ports for External LED Control
 - Supervisory Signal
- Compatible Controller: iCON100, iTDC, Standalone Controller, Third Party Controller

4. Identifying Supplied Parts

Please unpack and check the contents of the box.



**RFK101
(1ea)**

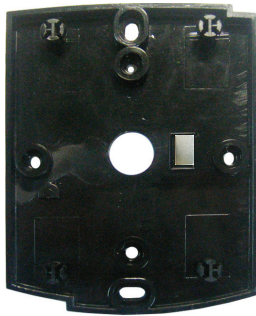

**Wall Mount
(1ea)**



**O-ring
(5ea)**



**User's Manual
(1copy)**



**3.5*40 Screw
(4ea)**



**3.5*12 Screw
(4ea)**



**Anchor Bolt
(4ea)**

5. Specification

Model		RFK101
Read Range	Passive Type	IDK50 / IMC125: Up to 2 inches (5cm) IDC80 / IDC170: Up to 4 inches (10cm)
	Active Type	IDA150 / IDA200 Compatible
Reading Time (Card)		30ms
Power / Current		DC12V / Max.150mA
Input Port	Default	2 Ports for External LED Control, 1 Port for External Buzzer Control
	Optional	3 Ports for External LED Control, 1 Port for External Buzzer Control
Output Format		26bit Wiegand, RS232 (default) / 4/8bit Burst for PIN (selectable) / ABA Track II (optional)
Keypad		12 Key Numeric Keypad with Back Lighting
LED Indicator		3 Array LED Indicators (Red, Green and Yellow)
Beeper		Piezo Buzzer
Operating Temperature		-35° to +65°C (-31° to +149°F)
Operating Humidity		10% to 90% relative humidity non-condensing
Color		Dark Pearl Gray
Material		Polycarbonate
Dimension (W x H x T)		87mm x 100mm x 31mm (3.4" x 3.94" x 1.22")
Weight		190g (0.42lbs)
Certification		FCC, CE, MIC

6. Installation

- 6-1. Use the provided Template on Page 16 to drill two 6-32 or M3 screw holes 3.3"(8.38cm) apart in vertical and one 1/2" hole at the center of these two holes.
(If you have installed electric gang box then skip this step.)
- 6-2. Make sure that magnet is attached by magnet guide of wall mount.
- 6-3. Using two 6-32 or M3 screws, install wall mount to the wall.
- 6-4. Insert 5 O-rings to the wall mount as indicated, then route the cable of the main unit through the center hole and push the main unit to wall mount to lock the main unit and make sure that the main unit is locked with wall mount.

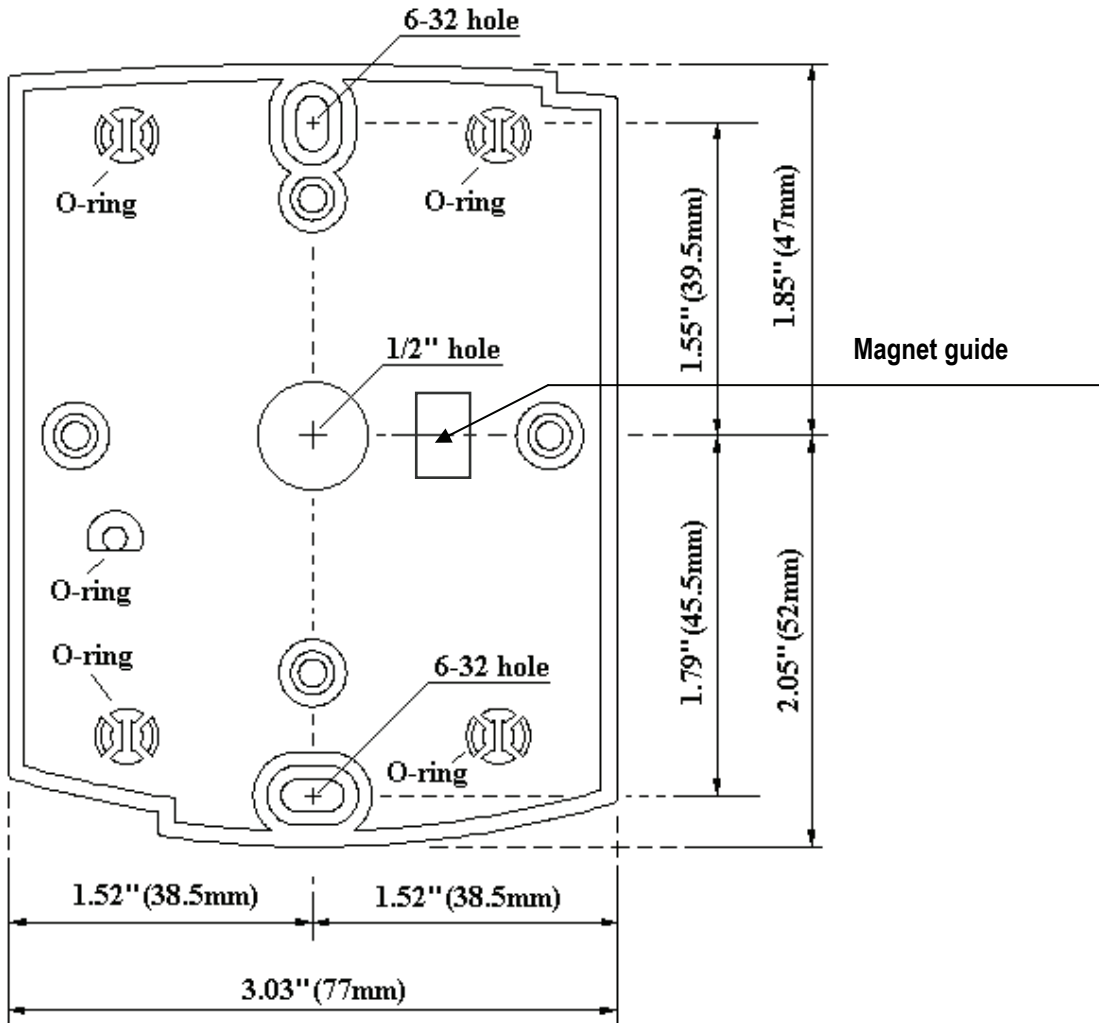

7. Wire Color Table of the Reader

SIGNAL	COLOR
Main Power (+12V)	Red
Power Ground (GND)	Black
Wiegand Data 0 Out / ABA Track II Data Out	Green
Wiegand Data 1 Out / ABA Track II Clock Out	White
Buzzer Control In	Blue
LED Control In (RED)	White with Red stripe
LED Control In (GREEN)	Yellow
LED Control In (YELLOW)	White with Blue stripe
Tamper Switch Out (NC)	White with Green stripe
Tamper Switch Out (COM)	Gray
RS232 (TX)	Purple
Not Connect	Brown
* Please cut out tail connector before installation.	

8. Wire Connection to Access Controller

8-1. **Wiring to control green LED (default)**

Output Format: 26bit Wiegand + RS232 (for Card) + 8bit Burst (for PIN)

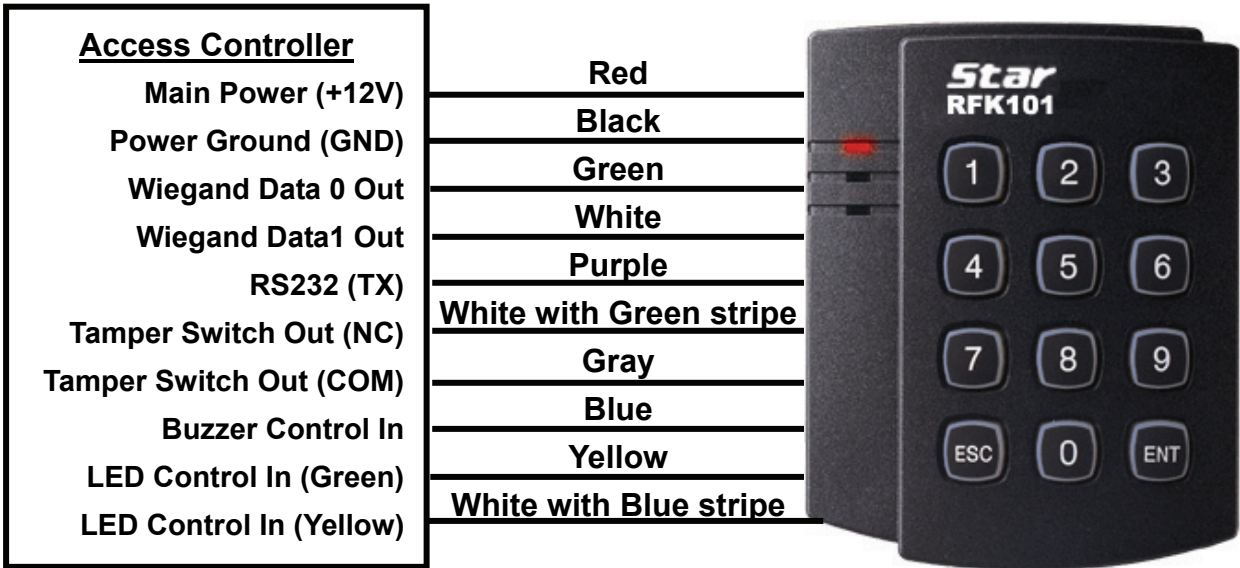

- The Reader transmits Card & PIN data on Wiegand Data 0, Wiegand Data 1 and RS232 (TX) lines.

8-2. Wiring to control red, green and yellow LEDs (optional)

Output Format: 26bit Wiegand + RS232 (for Card) + 8bit Burst (for PIN)

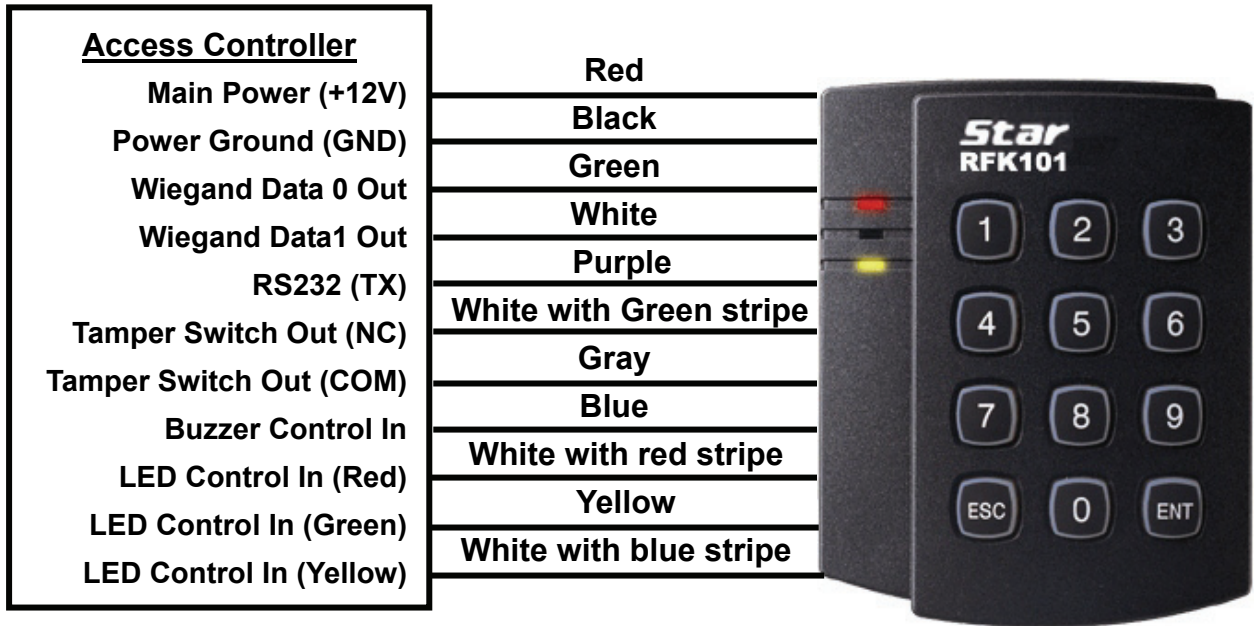

-The Reader transmits Card data to Wiegand Data 0, Wiegand Data 1 and RS232 (TX) line.

9. Operation

9-1. Connector Layout

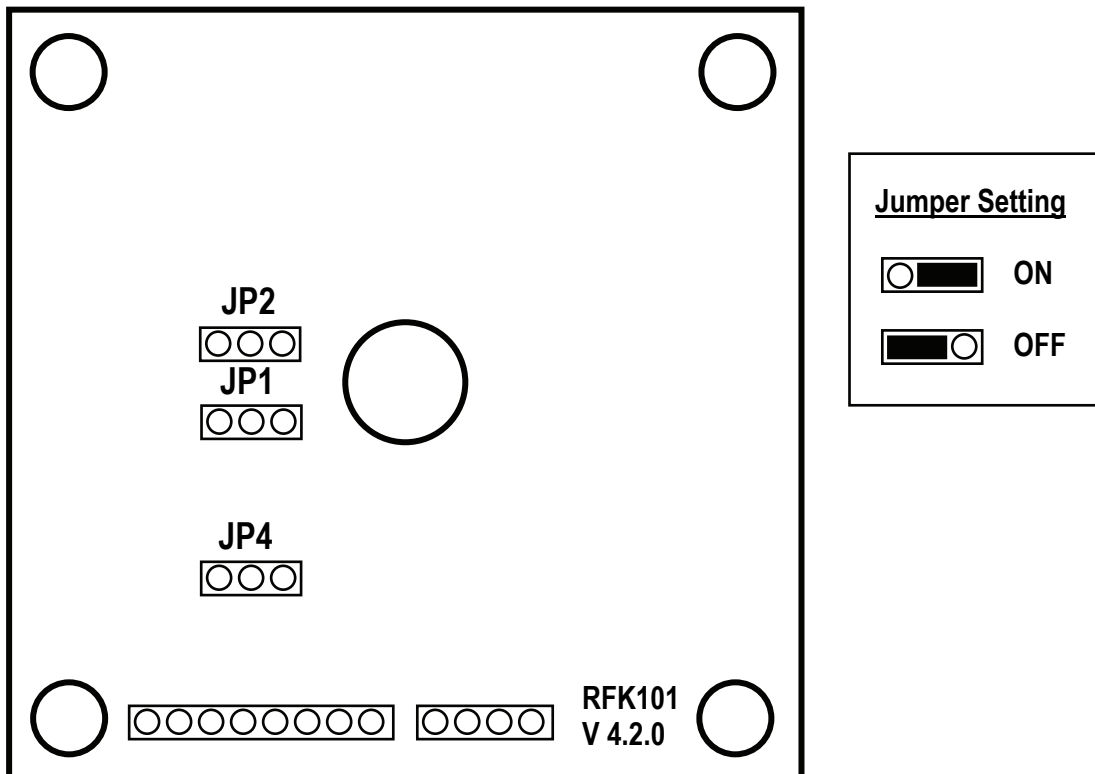

9-2. Output Mode Setting

Table 1. Jumpers Setting

JP1	JP2	Card Output Format	Keypad Output Format
ON	ON	<u>26bit Wiegand + RS232</u>	<u>8bit Burst</u>
ON	OFF	26bit Wiegand + RS232	26bit Wiegand + RS232
OFF	ON	26bit Wiegand + RS232	26bit Wiegand + RS232
OFF	OFF	26bit Wiegand + RS232	4bit Burst

※ **Note:** The default settings for JP1 and JP2 jumpers are “close”(short circuit).

JP4 is reserved for future use and currently not used.

9-3. Operation

9-3-1. Basic Operation

1. Once power is applied, you can hear 3 initial beeps while the 3 LEDs turn on. Then, the only red LED light stays on, indicating that the reader is in the standby mode after successful initialization and diagnostics.
2. Present an RF proximity card to the reader until you hear a beep sound and see the green LED blink. The reader will send the RF card data to the controller, then the green LED turns off again going back to the standby mode for the next reading.

3. 26bit Wiegand + RS232 Output Format

3-1. If you set the output to 26bit Wiegand + RS232 format and press numeric keys on the keypad, you can hear a beep sound with the yellow LED flashing, which indicates PIN entry start. Once you enter the PIN, press “ENT” key to finish PIN entry. The yellow LED will turn off indicating PIN entry is finished. The reader will then send the PIN data to the controller.

3-2. In the 26bit Wiegand + RS232 output format, a facility code is within the range of 0 to 255 and an ID (PIN) is in the range of 0 to 65535. If you do not finish your PIN entry with “ENT” key or if you do not press any key within 5 seconds, the reader will make error beeps “Beep Beep Beep” then clear the PIN data (no output) and return to the standby mode. An ID (PIN) you can enter via the keypad is from 1 to 8 digits.

e.g.) If you enter a 1-8 digit PIN,

① 1234ENT	Wiegand	00001234
	RS232	00001234
② 12345678ENT	Wiegand	12345678
	RS232	12345678

4. Burst + RS232 Output Format

4-1. When you set output to Burst + RS232 format and press numeric keys on the keypad, you can hear a beep sound and the green LED turns on indicating PIN entry start.

4-2. When you set output to Burst + RS232 format, PIN data sends 8bit Burst format if you press numeric keypad. And if you enter <ENT> key with 1 to 8 digit of keypad, PIN data sends RS232 format. In case of RS232 output format, if you do not finish PIN entry with "ENT" key and/or if you do not press any keypad for 5 seconds, clear PIN data (no output) and return to normal mode.

5. LED Control:

You may change the behavior of the green and yellow LEDs as follows;

- To keep the green LED turned on, connect the yellow wire to the GND.
- To keep the yellow LED turned on, connect the white wire with blue stripe to the GND.

For more information, please refer to **8. Wire Connection to Access Controller** on Page 7.

6. Beeper Control:

In normal operation, the reader sounds one beep when it reads a proximity card.

However additional beeps can be sounded to improve indication for access status (granted or denied) by wiring blue wire of the beeper control input to system ground level.

The beeper will remain on as long as the blue wire is connected to system ground.

7. Tamper Switch

The RFK101 has normal close (NC) type Tamper Switch. When the unit is installed with wall mount, the tamper switch output wires, the gray wire (COM) and the white with green stripe wire (NC) will be short circuits. When the unit is removed from the wall mount, the tamper switch output wires will be open circuits.

9-3-2. Advanced Operation

1. Supervisory Signal:

This unit sends supervisory signal through reader's output for a preset time.

2. Three LEDs Control:

To change the LED colors, you may connect the LED Control Input (Yellow wire for green LED, White with blue wire for yellow LED and White with red wire for red LED) to ground and relative LED will turn on while you are holding this wire to ground.

10. Output Format

10-1. 26bit Wiegand output format

1. Data format

Bit 1	: Even parity of bit 2 - bit 13
Bit 2 – 9	: Facility code (000 - 255)
Bit 10 – 25	: ID number (00000 - 65,535)
Bit 26	: Odd parity of bit 14 - bit 25

2. Timing diagram

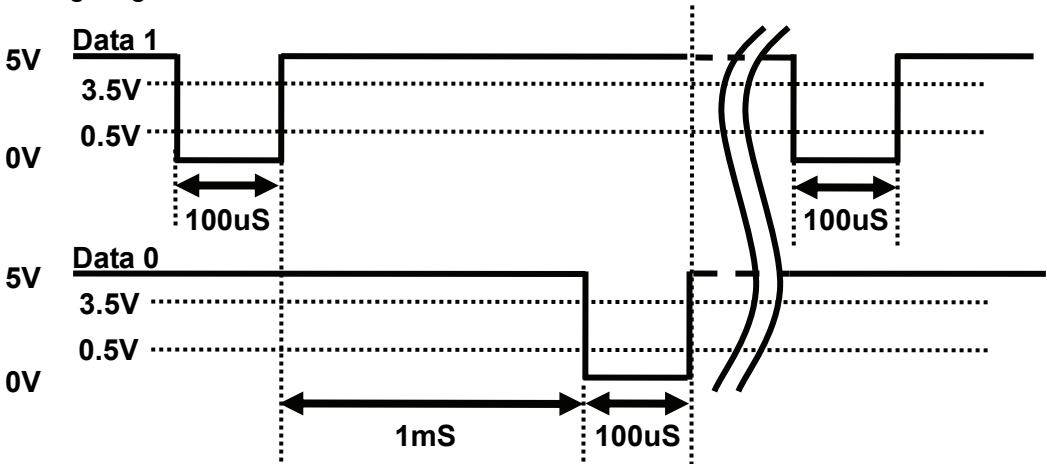

10-2. 4 / 8bit Burst output format (for PIN)

1. Data format

(4bit Burst output format)

Keypads	Binary	Hexa	Keypads	Binary	Hexa
0	0000	0	6	0110	6
1	0001	1	7	0111	7
2	0010	2	8	1000	8
3	0011	3	9	1001	9
4	0100	4	ESC	1010	A
5	0101	5	ENT	1011	B

(8bit Burst output format)

Keypads	Binary	Hexa	Keypads	Binary	Hexa
0	11110000	F0	6	10010110	96
1	11100001	E1	7	10000111	87
2	11010010	D2	8	01111000	78
3	11000011	C3	9	01101001	69
4	10110100	B4	ESC	01011010	5A
5	10100101	A5	ENT	01001011	4B

2. Timing diagram

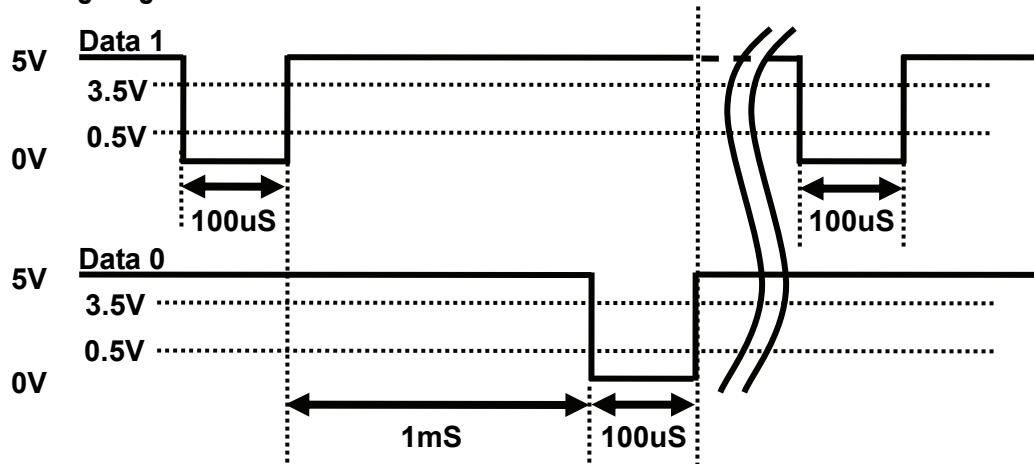

10-3. RS-232 output format

1. Data format (Baud rate: 9600bps)

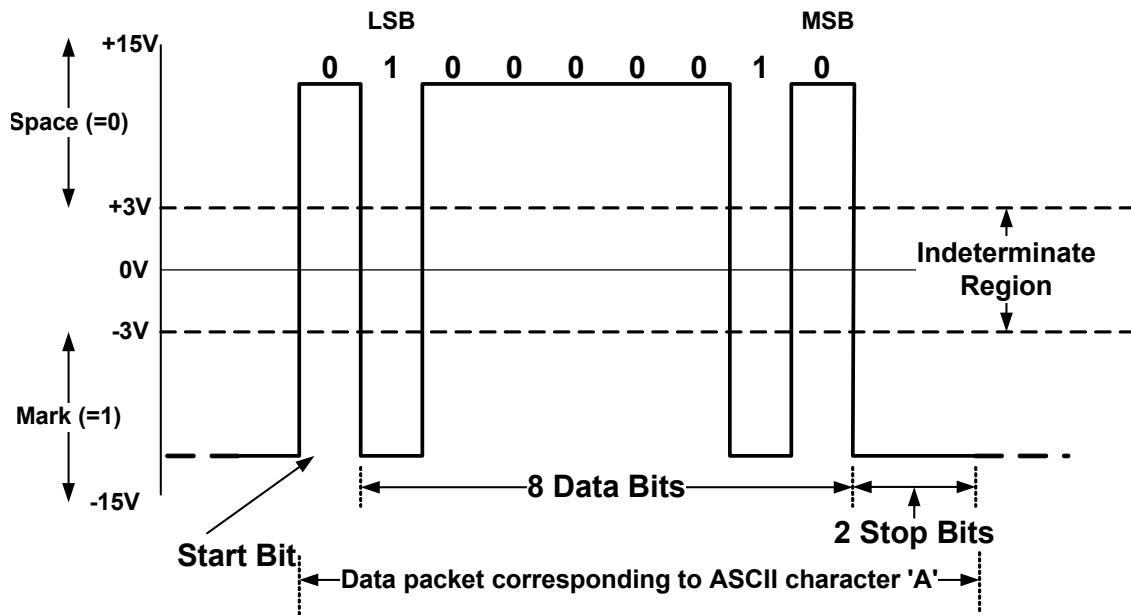

2. Data structure

START(0X02H)	DATA (8 Char)	END (0x03H)	LRC	(CARD output)
START(0X02H)	DATA (1- 8 Char)	END (0x03H)	LRC	(Keypad output)

11. FCC Registration Information

FCC REQUIREMENTS PART 15

Caution: Any changes or modifications in construction of this device which are not expressly approved by the responsible for compliance could void the user's authority to operate the equipment.

NOTE: This device complies with **Part 15 of the FCC Rules**.

Operation is subject to the following two conditions;

1. This device may not cause harmful interface, and
2. This device must accept any interference received, including interference that may cause undesired operation.

This equipment has been tested and found to comply with the limits for a **Class B Digital Device**, pursuant to **Part 15 of the FCC Rules**. These limits are designed to this equipment generates, uses, and can radiate radio frequency energy and, if not installed and used in accordance with the instructions, may cause harmful interference to radio communications.

However, there is no guarantee that interference will not occur in a particular installation. If this equipment does cause harmful interference to radio or television reception, which can be determined by turning the radio or television off and on, the user is encouraged to try to correct interference by one or more of the following measures.

1. Reorient or relocate the receiving antenna.
2. Increase the separation between the equipment and receiver.
3. Connect the equipment into an outlet on another circuit.
4. Consult the dealer or an experienced radio/TV technician for help.

12. Warranty Policy and Limitation of Liability

IDTECK warrants this product against defects in material and workmanship for 3 years from the date of purchase under normal customer use. This Warranty doesn't apply: 1) to any product which has been dismantled without authorization of IDTECK or/and has a damaged or detached QC label on its back side; 2) to any losses, defects, or damages caused by improper testing, operation, installation, maintenance, modification, alteration, or adjustment; 3) to any product with a damaged or faded serial number on it; or 4) to any losses, defects, or damages caused by lightning or other electrical discharge, natural disaster, misuse, accident or neglect.

This Limited Warranty is in lieu of all other warranties, obligations, or liabilities on the part of IDTECK, and IDTECK DISCLAIMS ANY AND ALL WARRANTY, WHETHER EXPRESS OR IMPLIED, OF MERCHANTABILITY OR FITNESS FOR A PARTICULAR PURPOSE. IDTECK does not, and cannot, know who is present, what property is located, where this product will be used; it would be extremely difficult to determine the actual damages that may result from a failure of the product to perform as anticipated; and the low price of this product is based upon the nature of the product provided and the limited liability that IDTECK assumes. IDTECK IS NOT RESPONSIBLE FOR ANY PERSONAL INJURY, PROPERTY DAMAGE OR LOSS, DIRECT, SPECIAL, INCIDENTAL OR CONSEQUENTIAL DAMAGES, OR OTHER LOSS, AND IDTECK'S MAXIMUM LIABILITY SHALL NOT IN ANY CASE EXCEED THE PURCHASE PRICE OF THE PRODUCT.

To obtain repair or replacement under the terms of this warranty, visit IDTECK's Website (<http://www.idteck.com>) and place an online RMA request. After an RMA code is issued, return the product along with the authorization RMA code.

RMA REQUEST FORM

IDTECK accepts only on-line RMA requests on our Website (www.idteck.com). Please provide us with basic information in the below form so that we can understand your problems better. Send us back this form with your products after an RMA code is issued on our Website. This form is not compulsory.

RMA Authorization Code :	
1. Company Name	
2. Model Name	
3. Serial No.	
4. Original Invoice No.	
5. Distributor	
6. Purchasing Date	
7. RMA Request Date	

Please check your problems.

<input type="checkbox"/> Card Reading	<input type="checkbox"/> Power	<input type="checkbox"/> Keypad
<input type="checkbox"/> Communication	<input type="checkbox"/> Relay	<input type="checkbox"/> LCD
<input type="checkbox"/> LED & Buzzer	<input type="checkbox"/> Registration	
<input type="checkbox"/> Others :		

IDTECK RMA Center >>

3F, 10/10-1/10-2, Dodang-Dong, Weonmi-Gu, Bucheon-Si, Gyeonggi-Do 157-030, Korea
 Telephone: 82.2.2659.0055 (HQ) / 82.32.671.5642 (RMA Center)
 Fax: 82.2.2659.0086 (HQ) / 82.32.671.5641 (RMA Center)
 Website: www.idteck.com
 e-Training Center: www.idtecktraining.com

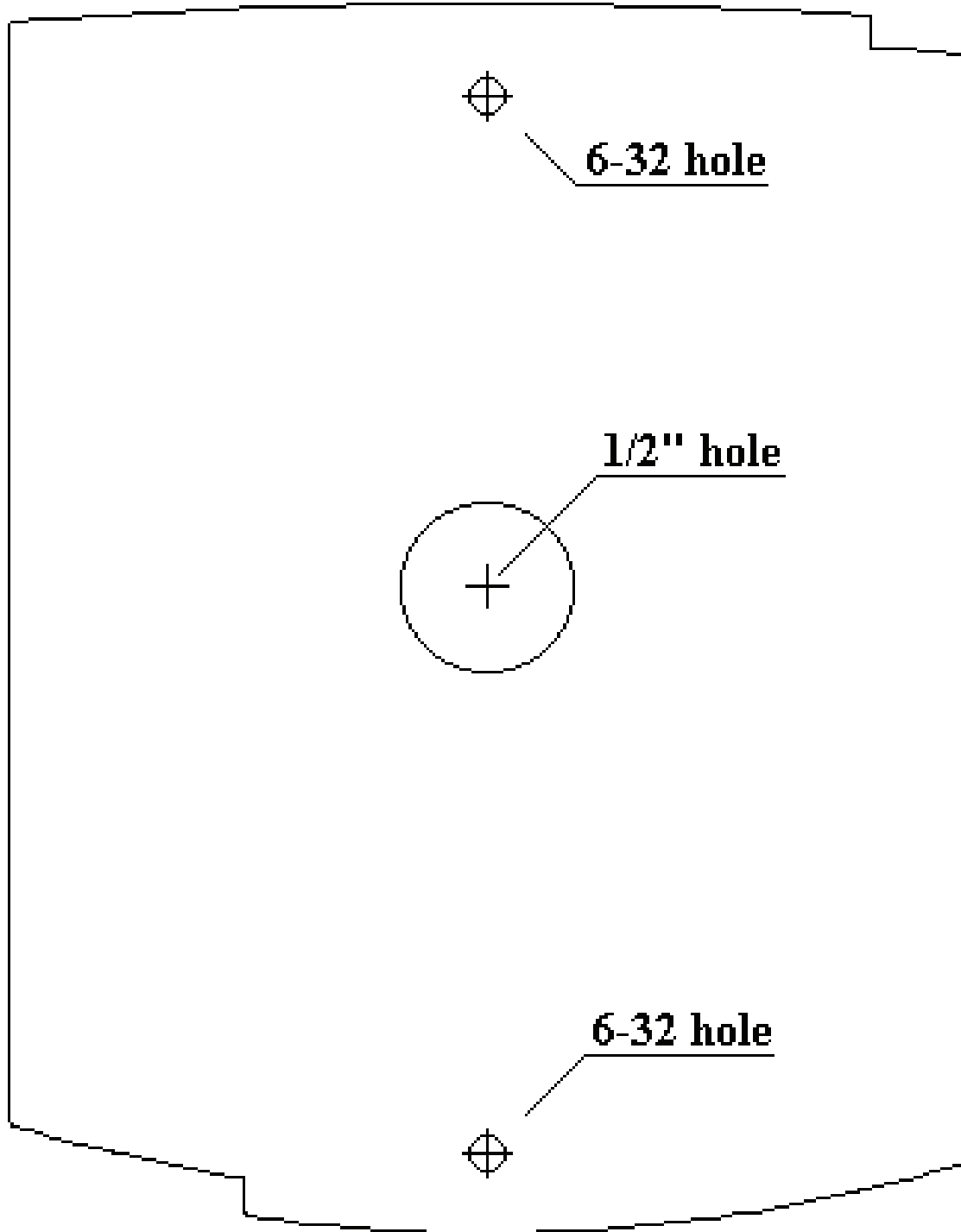
13. Template



The specifications contained in this manual are subject to change without notice at any time.

**5F, Ace Techno Tower B/D, 684-1, Deungchon-Dong,
Gangseo-Gu, Seoul, 157-030, Korea**

Tel : +82-2-2659-0055

Fax : +82-2-2659-0086

E-mail : webmaster@idteck.com